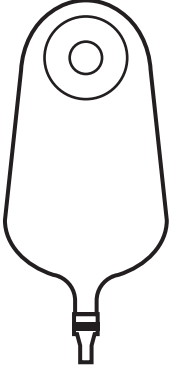
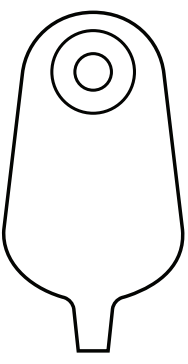
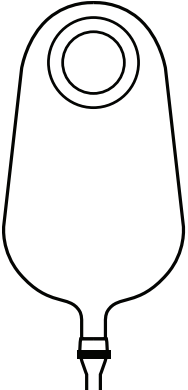

MARLEN Urostomy Supplies

Effective March 1, 2016
Order Blank

ITEM	PART NO.	PRICE
 <p>MARLEN E-Z Drain™ Urostomy Pouches Sizes: Infant, Child, Regular, Large</p>	Colors: Clear	EZD-36-218 \$41.50 Pkg. of 5
	White	EZD-36-219 \$41.50 Pkg. of 5
	Beige	EZD-36-225 \$41.50 Pkg. of 5

 <p>MARLEN All-Flexible™ Urostomy Pouches Sizes: Infant, Child, Regular, Large</p>	Colors: Clear	MAF-12-114 \$34.50 Pkg. of 5
	White	MAF-12-115 \$34.50 Pkg. of 5
	Beige	MAF-12-222 \$34.50 Pkg. of 5

 <p>MARLEN XTL™ E-Z Drain™ Urostomy Pouches Sizes: Regular, Large *For Stoma Openings 1-3/4" to 2-1/2"</p>	Color: Clear	XTL-EZD-24-212 \$41.50 Pkg. of 5
---	--------------	--

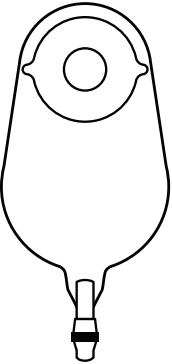
ITEM	PART NO.	PRICE
 <p>MARLEN Solo™ Reusable Urostomy Unit Sizes: Child, Regular, Large</p> <p>Note: When ordering, specify pouch size and stoma opening</p>	SU-3001	\$30.00 Each

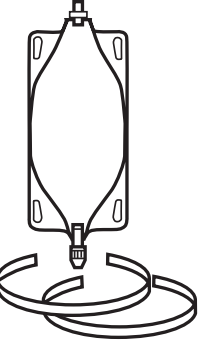
ACCESSORY ITEMS (CONTINUED ON BACK)	PART NO.	PRICE
 <p>MARLEN Leg Bag Kit with Regular size leg bag. For use with EZD-36 and Ultra Urostomy Pouches</p> <p>* (Contains Screw Connector with Washer Seal)</p> <p>Kit Contents 1-Leg Bag 2-Adj. Velcro Straps 1-Two-Foot Tubing *1-Screw Connector with Washer Seal</p>	MLB-300	\$24.00 Complete Kit
	MLB-300A	\$24.00 Complete Kit
 <p>Regular Size Leg Bag Straps (2 required) Tubing – (2 feet long)</p> <p>* Screw Connector with Washer Seal (For use with MAF-12, XTL-MAF-24 And MU-3R Appliances)</p> <p>Washer Seal Only (for Screw Connector)</p>	300-5	\$14.00 Ea.
	300-10	\$5.00 Pr.
	300-25	\$5.00 Ea.
	*310	\$5.00 Ea.
	315	\$2.00 Ea.

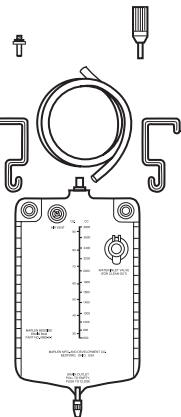
 <p>MARLEN Urinary Bedside Drain Bag Kit For use with EZD-36 and Ultra Urostomy Pouches</p> <p>* (Contains Screw Connector with Washer Seal)</p> <p>Kit Contents 1-Bedside Drain Bag 2-Plastic Hangers 1-Five-Foot Tubing *1-Screw Connector with Washer Seal</p>	MBD-8	\$29.50 Complete Kit
	*MBD-8A	\$29.50 Complete Kit
<p>Bedside Drain Bag Plastic Hangers (2 required) Tubing – (5 feet long)</p> <p>* Screw Connector with Washer Seal (For use with MAF-12, XTL-MAF-24 And MU-3R Appliances)</p> <p>Washer Seal Only (for Screw Connector)</p>	MBD-8-1	\$17.00 Ea.
	MBD-8-2	\$5.00 Pr.
	MBD-8-3	\$7.50 Ea.
	*310	\$5.00 Ea.
	315	\$2.00 Ea.

Please See Other Side for Additional Products

TEAR OFF

To:  **MARLEN MANUFACTURING & DEVELOPMENT CO.**
5150 Richmond Road • Bedford, Ohio 44146 U.S.A.
Phone: (216) 292-7060 • Fax: (216) 292-9196
marlenmfg.com

SECURITY BY DESIGN™

Name _____
Address _____
City _____ State _____ Zip _____

ORDER BLANK



Card No. _____
Expiration Date _____ 3-Digit Code _____
Phone Number _____
Signature _____ Date _____

For Office Use Only

INVOICE NO. _____
DATE REC. _____ BY _____

QUANTITY	PART NO.	ITEM	POUCH SIZE	STOMA OPENING SIZE	CONVEXITY	PRICE EACH	TOTAL











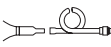













NOTE: We accept check, money order or credit card for payment.
(F.O.B. Bedford, Ohio)









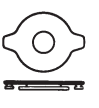

*Please choose a shipping method below:
 USPS UPS FedEx
If required, choose optional expedited service below:
 Next Day (additional cost) 2nd Day (additional cost)

TOTAL PRICE OF ITEMS \$ _____
***USA SHIPPING, PACKING AND HANDLING \$ 12.00**
TOTAL AMOUNT OF ORDER \$ _____

MARLEN Urostomy Supplies (Continued From Front)

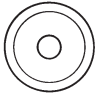
Effective March 1, 2016
Order Blank

ACCESSORY ITEM	PART NO.	PRICE
 <p>MARLEN Night Drainage Kit For use with MUPO-9, EZD-36 and Ultra Urostomy Pouches *(Contains Screw Connector with Washer Seal)</p> <p>Half-Gallon Plastic Container w/Special Cap Plastic Tubing (6 feet long) Rubber Tubing — (6 feet long) * Screw Connector with Washer Seal Washer Seal Only (for Screw Connector)</p>	MND-7	COMPLETE KITS \$24.00
	*MND-7A	\$24.00
	MND-7-4	EACH \$15.00
	MND-7-3	\$9.00
	MND-7-3R	\$9.00
	310	\$5.00
315	\$2.00	
 <p>MARLEN Drain Tube Extension For use with EZD-36 and Ultra Urostomy Pouches</p>	MDT-320	\$12.00 Each
 <p>MARLEN Drain Tube Extension With Screw Type Fitting For use with MAF-12, XTL-MAF-24 and MU-3R Appliances</p>	MDT-320-A	\$12.00 Each
 <p>MARLEN MaxSeal Protective Barrier Ring Note: Barrier Rings have an outside diameter of 2"</p>	9700	\$57.75 Pkg. of 10
 <p>MARLEN UltraSeal Flexible Barrier Ring Note: Barrier Rings have a 5/8" starter hole And an outside diameter of 2"</p>	9500	\$62.00 Pkg. of 10
 <p>MARLEN AquaTach Protective Hydrocolloid Skin Barrier 4" x 4" (10 cm x 10 cm) with 1/2" (12 mm) starter hole</p>	9100	\$29.50 Pkg. of 5
 <p>MARLEN Skin Shield Protective Adhesive Skin Barrier 4" x 4" (10 cm x 10 cm) with 1/2" (12 mm) starter hole</p>	9000	\$27.50 Pkg. of 5
 <p>MARLEN Double-Faced Adhesive Tape Discs 3-7/8" outside diameter (9.9 cm) – Pre-cut stoma openings up to 1-5/8" (4.2 cm)</p>	107	\$14.50 Pkg. of 10
 <p>MARLEN Extra-Large Double-Faced Adhesive Tape Discs Shaped to accommodate the Extra-Large XTL-55 and XTL-75 mounting rings.</p>	XTL-171	\$16.00 Pkg. of 10
 <p>MARLEN Protex Powder (Gum Karaya) 4 oz. (120 cc) Bottle</p>	P-116	\$19.00 Bottle
 <p>MARLEN Small Protex Powder Pad (Karaya Seal) Pre-cut with stoma opening sizes up to 1-1/2" (3.8 cm)</p>	112	\$20.00 Pkg. of 10
 <p>MARLEN Large Protex Powder Pad (Karaya Seal) Outside diameter of 3-3/4" (9.5 cm) will accommodate openings up to 2-1/2" (6.4 cm)</p>	PP-C-175	\$19.00 Pkg. of 5
 <p>MARLEN Protex Sheet 8" x 8" (20.3 cm x 20.3 cm) square</p>	PS-176	\$24.00 Each
 <p>MARLEN Plastic Foam Pads 4" diameter (10.2 cm) with pre-cut stoma openings</p>	FP-601	\$14.50 Pkg. of 10
<p>MARLEN Rubber-O-Ring Seal</p> <p>Pt. No. 103 is used with all mounting rings Except Extra-Large XTL Series</p> <p>Pt. No. XTL-161 is used only with Extra-Large XTL-55 and XTL-75 Mounting Rings</p>	103	\$4.25 Each
	XTL-161	\$5.25 Each
 <p>MARLEN Lock Ring</p>	605	\$11.50 Each
 <p>MARLEN Elastic Appliance Belt (Adult)</p>	104	\$12.50 Each
 <p>MARLEN Elastic Appliance Belt (Child)</p>	105	\$11.50 Each
 <p>MARLEN Urinary Drainage Fitting</p>	108	\$9.50 Each
 <p>MARLEN E-Z Drain Adapter</p>	340-EZD	\$5.50 Each
 <p>MARLEN Stoma Guide Strips</p>	603	\$11.50 Pkg. of 100
 <p>MARLEN Liquid Odour-Guard™ 4 oz. (120 cc) Bottle</p>	503	\$11.00
 <p>MARLEN Deodorizer 12 oz. (360 cc) Bottle</p>	504	\$12.50
 <p>MUCOSPERSE™ Mucous Dispersant 4 oz. (120 cc) Bottle</p>	507	\$11.00
 <p>MARLEN Eye Dropper Bottle 1 oz. (30 cc) Bottle</p>	402	\$4.25
 <p>MARLEN Plastic Airing Hook</p>	106	\$2.75 Each
 <p>3M Micropore Tape</p>	612	\$11.50 Pkg. of 3 Rolls

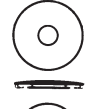
MOUNTING RING	PART NO.	PRICE
 <p>Flat All-Flexible Mounting Rings</p> <p>Basic All-Flexible 3-3/4" dia. (9.5 cm)</p> <p>White Vinyl Green Neoprene Rubber</p>	WV-101 GN-101	\$33.00 Each \$38.75 Each
 <p>Oval Flat 3-3/4" x 2-3/4" (9.5 cm x 7.0 cm)</p> <p>White Vinyl Green Neoprene Rubber</p>	WV-50 GN-50	\$33.00 Each \$38.75 Each
 <p>Compact Flat 3-3/4" x 3-1/8" (9.5 cm x 7.9 cm)</p> <p>White Vinyl Green Neoprene Rubber</p>	WV-45 GN-45	\$33.00 Each \$38.75 Each
 <p>Petite Flat 3-3/4" x 2-7/8" (9.5 cm x 7.3 cm)</p> <p>White Vinyl Green Neoprene Rubber</p>	WV-40 GN-40	\$33.00 Each \$38.75 Each
 <p>Convex All-Flexible Mounting Rings</p> <p>Oval Convex 3-3/4" x 2-3/4" (9.5 cm x 7.0 cm)</p> <p>White Vinyl Green Neoprene Rubber</p>	WV-60 GN-60	\$34.00 Each \$39.75 Each
 <p>Compact Convex 3-3/4" x 3-1/8" (9.5 cm x 7.9 cm)</p> <p>White Vinyl Green Neoprene Rubber</p>	WV-102 GN-102	\$34.00 Each \$39.75 Each
 <p>Petite Convex 3-3/4" x 2-7/8" (9.5 cm x 7.3 cm)</p> <p>White Vinyl Green Neoprene Rubber</p>	WV-42 GN-42	\$34.00 Each \$39.75 Each
 <p>Deep Convex All-Flexible Mounting Rings</p> <p>Basic Deep Convex 3-3/4" dia. (9.5 cm)</p> <p>White Vinyl Green Neoprene Rubber</p>	WV-80 GN-80	\$40.75 Each \$44.50 Each
 <p>Compact Deep Convex 3-3/4" x 3-1/8" (9.5 cm x 7.9 cm)</p> <p>White Vinyl Green Neoprene Rubber</p>	WV-85 GN-85	\$40.75 Each \$44.50 Each
 <p>Extra Large All-Flexible Mounting Rings</p> <p>XTL Oval Flat 4-1/2" x 3-1/2" (11.4 cm x 8.9 cm)</p> <p>White Vinyl</p>	XTL-55	\$47.50 Each
 <p>"XTL" Oval Convex 4-1/2" x 3-1/2" (11.4 cm x 8.9 cm)</p> <p>White Vinyl</p>	XTL-75	\$49.50 Each
 <p>Semi-Flexible Mounting Rings</p> <p>Basic Regular Convex 3-5/8" dia. (9.2 cm)</p> <p>Compact Regular Convex 3-5/8" x 3-1/8" (9.2 cm x 7.9 cm)</p> <p>Basic Medium Convex 4" dia. (10.2 cm)</p> <p>Compact Medium Convex 3-5/8" x 3-1/8" (9.2 cm x 7.9 cm)</p>	SF-10 SF-20 SF-15 SF-65	\$47.50 Each \$47.50 Each \$49.50 Each \$49.50 Each