

TRADITIONAL *MARLEN Ostomy Products*

RE-USABLE UROSTOMY PRODUCTS

SOLO® Urostomy Unit

A one-piece unit featuring a convex mounting ring permanently sealed to an E-Z Drain™ pouch. Available in stoma sizes from 1/2" to 1-5/8" (in 1/8" increments).



SU-3001
Available in clear.

Pouch Size	Length "A"	Width "B"	Capacity
Child	7-5/8 in./19.4 cm	4-5/8 in./12.4 cm	10 oz./300 cc
Regular	8-5/8 in./21.9 cm	5 in./12.7 cm	15 oz./450 cc
Large	10 in./25.4 cm	5-3/8 in./13.6 cm	20 oz./600 cc

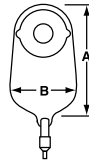

E-Z Drain™ Urostomy Pouch

Sealed in "push-pull" valve makes the E-Z Drain pouch easy to use. No separate fittings required. Constructed of lightweight plastic. Requires separate mounting ring.

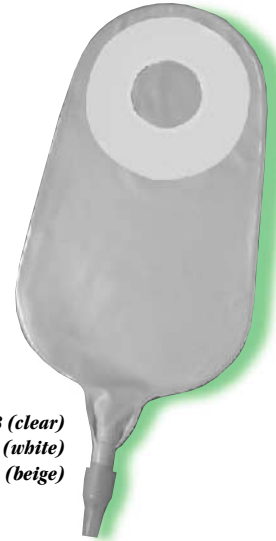

EZD-36-218 (clear)
EZD-36-219 (white)
EZD-36-225 (beige)

Pouch Size	Length "A"	Width "B"	Capacity
Infant	6-1/2 in./16.5 cm	3-1/2 in./8.9 cm	5 oz./150 cc
Child	7-5/8 in./19.4 cm	4-5/8 in./12.4 cm	10 oz./300 cc
Regular	8-5/8 in./21.9 cm	5 in./12.7 cm	15 oz./450 cc
Large	10 in./25.4 cm	5-3/8 in./13.6 cm	20 oz./600 cc

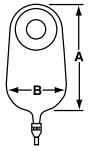

XTL-E-Z Drain™ Urostomy Pouch

A lightweight E-Z Drain pouch designed specifically for larger stoma openings (1-3/4" to 2-1/2"). Requires separate XTL mounting ring. Two sizes available: Regular and Large.

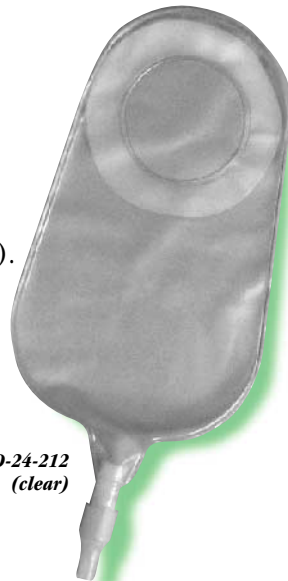

XTL-EZD-24-212
(clear)

Pouch Size	Length "A"	Width "B"	Capacity
Regular	8-7/8 in./22.5 cm	5 in./12.7 cm	14 oz./420 cc
Large	10-1/2 in./26.7 cm	5-3/8 in./13.6 cm	18 oz./540 cc

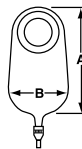

All-Flexible Plastic Urostomy Pouch

A lightweight plastic pouch for stoma openings up to 1-5/8". Requires separate mounting ring and drainage fitting (Pt. No. 108).



MAF-12-114 (clear)
MAF-12-115 (white)
MAF-12-222 (beige)

Pouch Size	Length "A"	Width "B"	Capacity
Infant	6-1/2 in./16.5 cm	3-1/2 in./8.9 cm	5 oz./150 cc
Child	7-5/8 in./19.4 cm	4-5/8 in./12.4 cm	10 oz./300 cc
Regular	8-5/8 in./21.9 cm	5 in./12.7 cm	15 oz./450 cc
Large	10 in./25.4 cm	5-3/8 in./13.6 cm	20 oz./600 cc

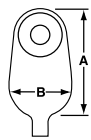

TRADITIONAL MARLEN Ostomy Products

Latex Rubber Urostomy Pouch

Durable, reusable long-lasting pouch. Requires separate semi-flexible mounting ring and drainage fitting (Pt. No. 108).

MU-3R-C (Child)
MU-3R-R (Regular)
MU-3R-L (Large)
Available in white.

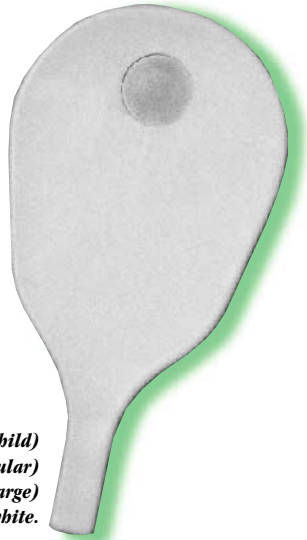

Pouch Size	Length "A"	Width "B"	Capacity
Child	6-7/8 in./17.5 cm	3-1/8 in./7.9 cm	8 oz./240 cc
Regular	7-5/8 in./19.4 cm	5-3/8 in./13.6 cm	13 oz./390 cc
Large	10-3/8 in./26.4 cm	5-1/4 in./13.3 cm	24 oz./720 cc

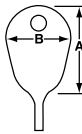

Free Flow™ Urostomy Pouch

DISPOSABLE, easy-to-apply, self-adhering pouch for ureterostomy and ileal bladder diversions. Free Flow stem allows unobstructed flow — even if pouch twists. Ideal for post-operative use. (Available with non-return anti-reflux MUPO-9F). Starter hole of 1/2" can be easily cut up to 2-1/8".

MUPO-9
Available in clear.

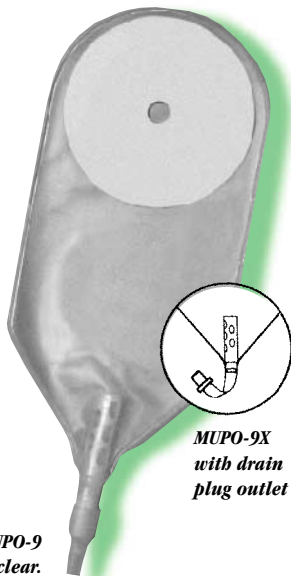

MUPO-9X
with drain
plug outlet

Pouch Size	Length "A"	Width "B"	Capacity
Pediatric	7-1/2 in./19.0 cm	4-1/8 in./10.5 cm	7 oz./210 cc
Adult	9-3/4 in./24.8 cm	4-5/8 in./11.8 cm	15 oz./450 cc

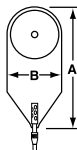

Also available:

Leg Bag Kit with Regular Size Leg Bag MLB-300

Adjustable, non-binding Velcro leg straps. Lightweight. Leak-proof. Built-in flutter valve to prevent backflow. Capacity is 17 oz./480 cc. A large leg bag (35 oz./1 liter) is also available (12-1/4" x 5"/31.1 cm x 12.7 cm).

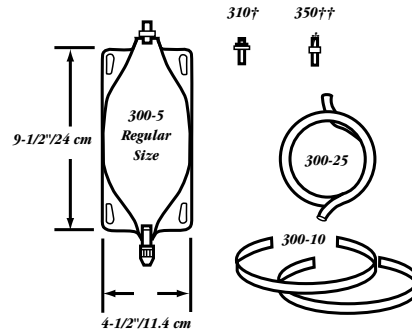

Night Drainage Kit — MND-7

For use with all Marlen urostomy pouches. One-half gallon plastic container collects drainage while user is sleeping. Eliminates the need for frequent emptying of pouch. Available with 6-foot plastic or rubber tubing.

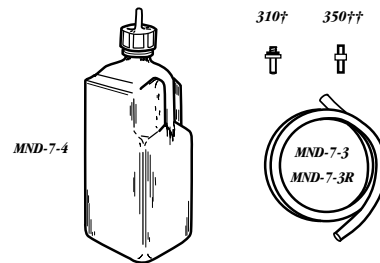

Bedside Drain Bag Kit MBD-8

For use with all Marlen urostomy pouches. Constructed of durable plastic. Conveniently hooks on to the side of the bed. Bag capacity is 90 ounces (2800 cc).

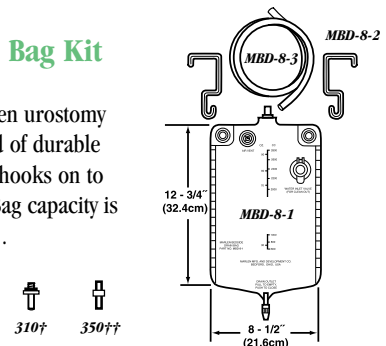

† Screw connector with washer seal for use with MAF and MU-3R pouches
†† Plastic connector for use with MUPO-9X



Marlen Manufacturing & Development Co.

5150 Richmond Road • Bedford, Ohio 44146 • USA
Phone (216) 292-7060 • Fax (216) 292-9196

E-mail: info@marlenmfg.com • Web: www.marlenmfg.com